

LIECHTENSTEIN (HEADQUARTERS)
NEUTRIK AG, Im alten Riet 143, 9494 Schaan
T +423 237 24 24, F +423 232 53 93, neutrik@neutrik.com

GERMANY / NETHERLANDS / DENMARK / AUSTRIA
Neutrik Vertriebs GmbH, Felix-Wankel-Strasse 1, 85221 Dachau, Germany
T +49 8131 28 08 90, neutrik@neutrik.de

GREAT BRITAIN
Neutrik (UK) Ltd., Westridge Business Park, Cothey Way
Ryde, Isle of Wight PO33 1 QT
T +44 1983 811 441, sales@neutrik.co.uk

FRANCE
Neutrik France SARL, Rue du Parchamp 13, 92100 Boulogne-Billancourt
T +33 1 41 31 67 50, info@neutrik.fr

USA / CANADA / MEXICO / SOUTH AMERICA
Neutrik USA Inc., 4115 Taggart Creek Road, Charlotte, North Carolina, 28208
T +1 704 972 3050, info@neutrikusa.com

JAPAN
Neutrik Limited, Yusen-Higashinohbashi-Ekimaie Bldg., 3-7-19
Higashinohbashi, Chuo-ku, Tokyo 103
T +81 3 3663 47 33, mail@neutrik.co.jp

HONG KONG
Neutrik Hong Kong Ltd., Suite 18, 7th Floor Shatin Galleria
Fotan, Shatin
T +852 2687 6055, sales@neutrik.com.hk

CHINA
Ningbo Neutrik Trading Co., Ltd., Shiqi Street, Yinxian Road West
Fengjia Villiage, Hai Shu Area, Ningbo, Zhejiang, 315153
T +86 574 88250833, sales@neutrik.com.cn

REAN Product Guide 2022/02 V03 - Data subject to change without prior notice. © 2022® ALL RIGHTS RESERVED

Product Guide



THE SMART WAY TO CONNECT

ASSOCIATED COMPANIES

Contrik AG
Steinackerstrasse 35, 8902 Urdorf, Switzerland
T +41 44 736 50 10, contrik@contrik.ch























H. Adam GmbH
Felix-Wankel-Straße 1, 85221 Dachau, Germany
T +49 08131 28 08-0, anfrage@adam-gmbh.de

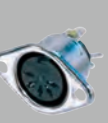

www.rean-connectors.com

REAN[®]
REAN a brand of Neutrik Group



Outdoor Z Series XLR Connectors				P. 6
Outdoor Z Series RJ45 Connectors				P. 8
TINY XLR Connectors				P. 10
XLR Connectors				P. 14
Plugs & Jacks				P. 22
Adapters & RCA				P. 36
Loudspeaker Connectors				P. 40
Power & Data Connectors				P. 42
DIN Connectors				P. 48
Dual banana Plug				P. 50
Stage Box & Patch Panels				P. 52



REAN

With REAN, the world's leading supplier of professional audio and video connectors – the Neutrik Group – offers a second global brand with a comprehensive product range.

Excellent cost-performance ratio, robust design and reliable functionality are the strengths of REAN.

Based on long-time know-how connectors for professional audio-/ lighting- and digital signage applications are developed and produced on up to date production facilities. An efficient logistics system and a global sales network make a high availability and short delivery times possible. The REAN product range is the alternative solution for cost sensitive applications.

REAN - A brand of Neutrik Group.

**ROBUST
RELIABLE
COMPREHENSIVE**

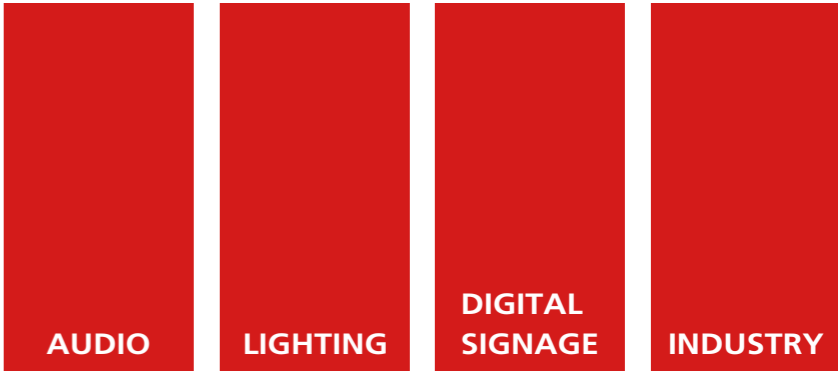

THE SMART WAY TO CONNECT



Outdoor Z Series XLR



- Rugged sealed XLR connector range for outdoor application
- UL94 V-0 rated materials
- Chrome&Black plated with fashionable finish and better abrasion performance
- IP65 rating provides outdoor protection under mated condition
- Gold&Tin plated for best conductivity

RCX*F-Z-00*

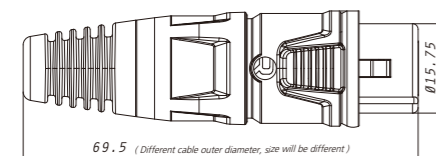

RCX*M-Z-00*

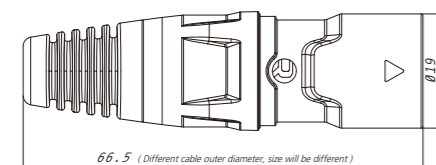

RRX3F-Z-00*

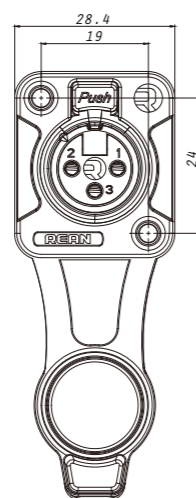

RRX3M-Z-00*

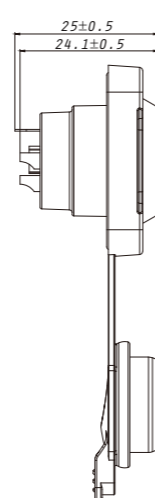
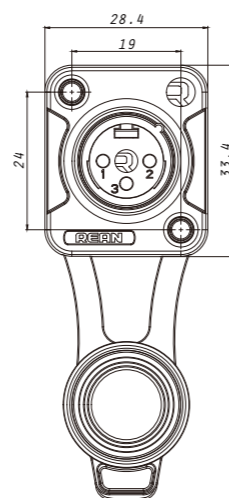

THE SMART WAY TO CONNECT

Ordering Information

Article Name	Details
Z Series XLR	
RCX*F-Z-000	3/5 pole female XLR cable connector, IP65 rating protection, chrome plated housing, tin plated contacts
RCX*F-Z-001	3/5 pole female XLR cable connector, IP65 rating protection, black plated housing, tin plated contacts
RCX*F-Z-002	3/5 pole female XLR cable connector, IP65 rating protection, chrome plated housing, gold plated contacts
RCX*M-Z-000	3/5 pole male XLR cable connector, IP65 rating protection, chrome plated housing, tin plated contacts
RCX*M-Z-001	3/5 pole male XLR cable connector, IP65 rating protection, black plated housing, tin plated contacts
RCX*M-Z-002	3/5 pole male XLR cable connector, IP65 rating protection, chrome plated housing, gold plated contacts
RRX*F-Z-000	3/5 pole female XLR receptacle, D-Size Flange, solder cups, IP65 protection, chrome plated housing, tin plated contacts
RRX*F-Z-001	3/5 pole female XLR receptacle, D-Size Flange, solder cups, IP65 protection, black plated housing, tin plated contacts
RRX*F-Z-002	3/5 pole female XLR receptacle, D-Size Flange, solder cups, IP65 protection, black plated housing, gold plated contacts
RRX*M-Z-000	3/5 pole male XLR receptacle, D-Size Flange, solder cups, IP65 protection, chrome plated housing, tin plated contacts
RRX*M-Z-001	3/5 pole male XLR receptacle, D-Size Flange, solder cups, IP65 protection, black plated housing, tin plated contacts
RRX*M-Z-002	3/5 pole male XLR receptacle, D-Size Flange, solder cups, IP65 protection, black plated housing, gold plated contacts

Note: 1) Above products are provided in REAN plastic package with -1 for the article suffix, if need bulk package, - 0 for the article suffix and must be ordered in multiples of 100 pcs;
2) *: contact number (3 or 5)

Specification Cable Connectors Receptacles

Electrical	Cable Connectors	Receptacles
Contact resistance	≤ 5 mΩ	≤ 5 mΩ
Dielectric strength	1.5 kV dc	1.5 kV dc
Insulation resistance	> 10 GΩ (initial)	> 10 GΩ (initial)
Rated current per contact	16 A (3 pole) / 7.5 A (5 pole)	16 A (3 pole) / 7.5 A (5 pole)
Rated voltage	< 50 V	< 50 V

Mechanical

Lifetime	> 1'000 mating cycles	> 1'000 mating cycles
Insertion / Withdrawal force	≤ 60 N	≤ 60 N
Cable O.D.	5.0 - 8.0 mm	Mounting direction Front mounting
Wiresize (max.)	1.5 mm ² /16 AWG(3 pole)/1.0 mm ² /18 AWG(5 pole)	Chassis shape D
Wiring	Solder contacts	Solder contacts
Locking device	Locking device	Locking device

Material

Bushing	Polyamide	-
Bronze contact and plating	Tin (-000 & - 001) / AU (-002) plating	Tin (-000 & - 001) / AU (-002) plating
Insert	Polyamide (UL94-V0)	Polyamide (UL94-V0)
Locking element	Zinc diecast (latch)	CK67 (spring)
Zinc diecast shell and plating	Chrome (-000) / Black (-001 & -002) plating	Chrome (-000) / Black (-001 & -002) plating
Strain relief	Polyamide	-
Sealing jacket	Rubber	Rubber

Environmental

Flammability	UL 94-V0
Protection class	IP65 (Mated or closed with rubber cap)
Standard compliance	IEC 61076-2-103
Solderability complies with	IEC 68-2-20
Temperature range	-20 °C to +70 °C

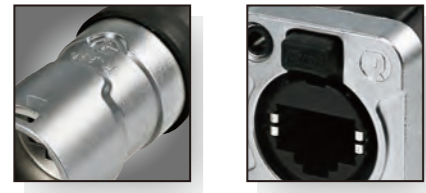

Outdoor RJ45/Ethernet Connectors



RCEM-Z-000



RRE8F-Z-000



- The RJ45 protection system for harsh and demanding environment
- Provide protection for the fragile RJ45 to ensure a stable Ethernet connection
- D-shape metal flange, stable and reliable
- IP65 protection when mating with coped Z-Series Ethernet receptacle
- UL94 V-0 rated materials
- Diecast shell cable carrier accepts the most common RJ45 plugs

RCEM-Z-00*

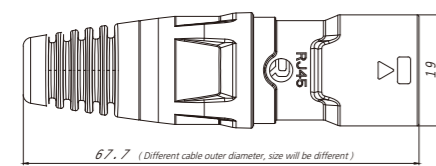

RRE8F-Z-00*

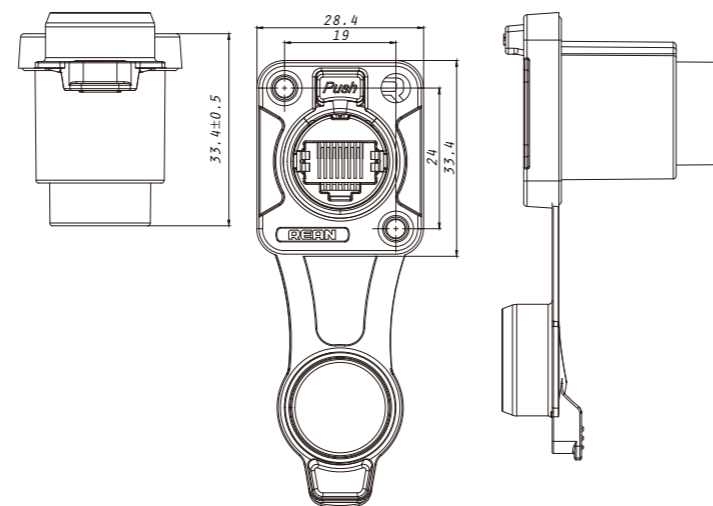

THE SMART WAY TO CONNECT

Ordering Information

Article Name	Details
RJ45 Cable Carriers	
RCEM-Z-000	Rugged RJ45 cable connector carrier, IP65 rating protection, chrome plated housing
RCEM-Z-001	Rugged RJ45 cable connector carrier, IP65 rating protection, black plated housing

RJ45 Receptacles	
RRE8F-Z-000	Rugged RJ45 D-size feedthrough, IP65 rating protection, chrome plated housing, with sealing cap
RRE8F-Z-001	Rugged RJ45 D-size feedthrough, IP65 rating protection, black plated housing, with sealing cap

Note: Above products are provided in REAN plastic package with -1 for the article suffix, if need bulk package, - 0 for the article suffix and must be ordered in multiples of 100 pcs

Specification

	Cable carriers	Receptacles
--	----------------	-------------

Electrical		
Contact resistance	-	≤ 100 mΩ
Dielectric strength	-	1kV dc
Frequency range	-	1 – 100 MHz
Insulation resistance	-	> 5 GΩ (initial)
Rated current per contact	-	1.5 A
Rated voltage	-	< 50 V
Transmission performance	-	CAT 5e

Mechanical		
Lifetime	> 1'000 mating cycles	> 1'000 mating cycles
Insertion / Withdrawal force	≤ 60 N	≤ 60 N
Cable O.D.	5.0 - 8.0 mm	-
Wiring	-	Feedthrough
Locking device	-	Latch lock
Mounting direction	-	Front mounting
Chassis shape	-	D

Material		
Shell	Zinc diecast	Zinc diecast
Shell plating	Chrome (-000) / Black (-001)	Chrome (-000) / Black (-001)
Strain relief	Polyacetal (POM)	-
Contact	-	Bronze
Contact plating	-	AU
Insert	-	Polyamide (UL94-V0)
Locking element	-	Zinc diecast

Environmental		
Flammability	UL 94-V0	
Protection class	IP65 (Mated or closed with rubber cap)	
Standard compliance	TIA/EIA 586B, IEC 11801	
Temperature range	-20 °C to +70 °C	



TINY XLR Cable Connectors



RT3FC-B RT4FC-B-W RT4FCT-B RT5MC-B

- Available in 3,4,5 pin configuration
- Quick and easy assembly
- Rugged metal shell, excellent flexibility
- Shielding system - Isolate noise and electromagnetic interference
- Rugged direct locking mechanism ensures a secure connection
- RT*FC-B sealing cap is available, waterproof when mated with RT*MP

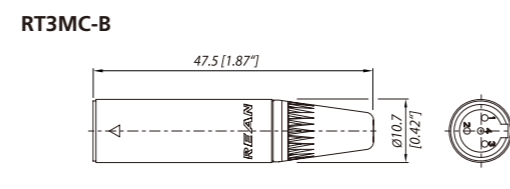
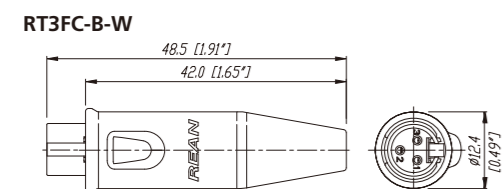
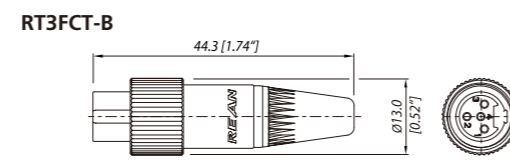
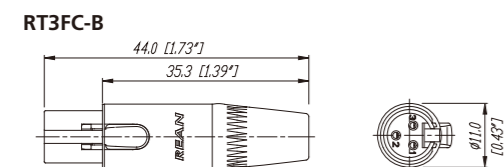

Female Pin Layout (Front)

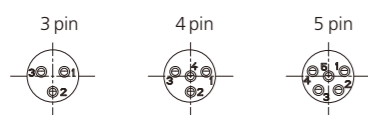

Male Pin Layout (Front)

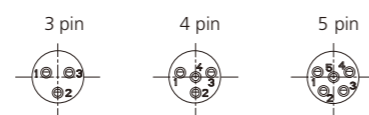

Ordering Information

Article Name		Details
Female	Male	
RT3FC-B	RT3MC-B	3 pole female/male TINY XLR cable connector, black metal housing, gold plated contacts, REAN plastic packaging
RT4FC-B	RT4MC-B	4 pole female/male TINY XLR cable connector, black metal housing, gold plated contacts, REAN plastic packaging
RT5FC-B	RT5MC-B	5 pole female/male TINY XLR cable connector, black metal housing, gold plated contacts, REAN plastic packaging

Waterproof Female Cable Connectors

RT3FC-B-W	3 pole female TINY XLR connector, black metal housing, waterproof bushing, gold plated contacts, REAN plastic packaging
RT4FC-B-W	4 pole female TINY XLR connector, black metal housing, waterproof bushing, gold plated contacts, REAN plastic packaging
RT5FC-B-W	5 pole female TINY XLR connector, black metal housing, waterproof bushing, gold plated contacts, REAN plastic packaging

Screw Locking Female Connectors

RT3FCT-B	3 pole female TINY XLR connector, black metal housing and nut, gold plated contacts, REAN plastic packaging
RT4FCT-B	4 pole female TINY XLR connector, black metal housing and nut, gold plated contacts, REAN plastic packaging
RT5FCT-B	5 pole female TINY XLR connector, black metal housing and nut, gold plated contacts, REAN plastic packaging

Note: Above products provide bulk package with -0 for the article suffix and must be ordered in multiples of 100 pcs

Specification	Cable Connectors RT*FC-B/RT*MC-B*	Screw Locking RT*FCT-B
---------------	--------------------------------------	---------------------------

Electrical

Contact rated current	< 5 A	< 5 A
Contact resistance	≤ 10 mΩ	≤ 10 mΩ
Dielectric strength	>1 GΩ	>1 GΩ
Insulation resistance	>500 V rms	>500 V rms

Mechanical

Lifetime	> 1'000 mating cycles	> 1'000 mating cycles
Cable O.D.	2.0 - 4.5 mm	2.0 - 4.5 mm
Wiring	Solder contacts	Solder contacts
Wiresize (max.)	0.22 mm ² / 24 AWG	0.22 mm ² / 24 AWG

Material

Boot	ABS+TPU	ABS+TPU
Contact	Female : Bronze / Male: Brass	Bronze
Contact plating	Au	Au
Insert	PA66+30% GF	PA66+30% GF
Shell / Tube	Zinc alloys / Aluminum	Zinc alloys / Aluminum
Shell / Tube plating	Nickel / Black anodized	Nickel / Black anodized
Strain relief	POM	POM
Carrier	EPDM	-
Locking nut	-	Al, black anodized

Environmental

Temperature range	-30°C to +85°C
Solderability complies with	IEC68-2-20

THE SMART WAY TO CONNECT

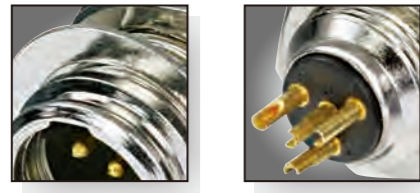

TINY XLR Receptacles

TINY XLR Adapters



RT3MP



RT5MPR



RA3FT-B



RA3MT-B

- 3, 4, 5 pole front / rear mountable
- Waterproof even under unmated condition
- Waterproof connection when mated with RT*FC-B-W

- Convenient and quick TINY XLR interconnected solution
- Ruggedized metal shell
- 3 pole TINY XLR - male / female XLR

RT3MP

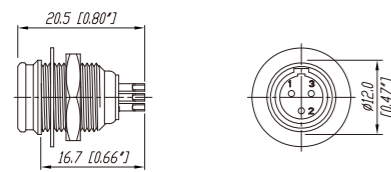

Panel Cutouts

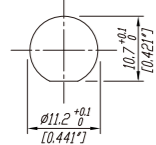

Pin Layout (front)

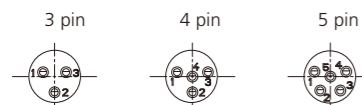

RA3FT-B

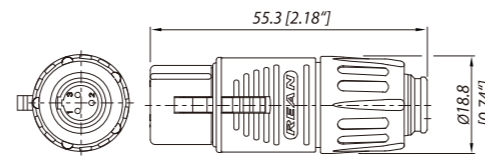

RA3MT-B

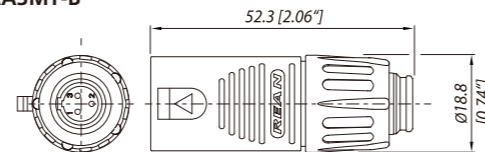

Ordering Information

Article Name	Details
Receptacles	
RT3MP	3 pole male TINY XLR receptacle, nickel plated metal housing, gold plated contacts, max. panel thickness: 3 mm, REAN plastic package
RT4MP	4 pole male TINY XLR receptacle, nickel plated metal housing, gold plated contacts, max. panel thickness: 3 mm, REAN plastic package
RT5MP	5 pole male TINY XLR receptacle, nickel plated metal housing, gold plated contacts, max. panel thickness: 3 mm, REAN plastic package
Rear Mountable Receptacles	
RT3MPR	3 pole male receptacle, rear mountable, nickel plated housing, gold plated contacts, max. panel thickness: 3 mm, REAN plastic package
RT4MPR	4 pole male receptacle, rear mountable, nickel plated housing, gold plated contacts, max. panel thickness: 3 mm, REAN plastic package
RT5MPR	5 pole male receptacle, rear mountable, nickel plated housing, gold plated contacts, max. panel thickness: 3 mm, REAN plastic package
Adapters	
RA3FT-B	3 pole TINY XLR adapter, male to female, black metal housing, gold plated contacts, REAN plastic package
RA3MT-B	3 pole TINY XLR adapter, female to male, black metal housing, gold plated contacts, REAN plastic package

Note: Above products provide bulk package with -0 for the article suffix and must be ordered in multiples of 100 pcs

Specification	Receptacles RT*MP	Adapters RA3F/M-B
---------------	----------------------	----------------------

Electrical		
Contact rated current	< 5 A	< 5 A
Contact resistance	≤ 5 mΩ	≤ 5 mΩ
Insulation resistance	>1 GΩ	>1 GΩ
Dielectric strength	>500 V rms	>500 V rms

Mechanical		
Lifetime	> 1'000 mating cycles	> 1'000 mating cycles
Wiring	Solder contacts	-
Wiresize (max.)	0.22 mm ² / 24 AWG	-

Material		
Contact	Brass	Female: Bronze / Male: Brass
Contact plating	Au	Au
Insert	PA66+30% GF	PA66+30% GF
Shell	Zinc alloys	Zinc alloys
Shell plating	Nickel	Black

Environmental		
Temperature range	-30°C to +85°C	-20°C to +65°C
Solderability complies with	IEC68-2-20	-



XLR Cable Connectors



- Ergonomic design, easy to use
- Rugged zinc diecast housing, long lifetime
- Chuck type strain relief provides the best cable retention, easy to assembly
- Provide rotatable angle of right-angle products
- Rubber boot ensure the best cable protection
- Rugged latch locking system, provides secure connection

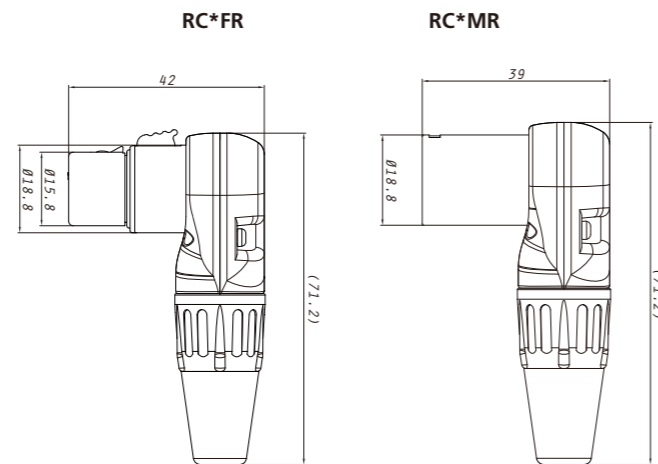
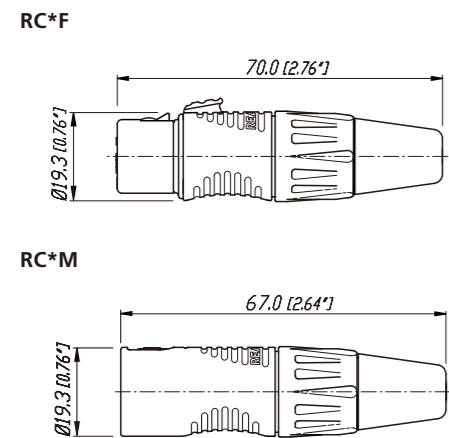

Ordering Information

Article Name	Details	
Straight Angle XLR		
RC*F	RC*M	3, 4, 5, 7 pole female/male XLR connectors, nickel plated metal housing, silver plated contacts, REAN plastic package
RC*F-B	RC*M-B	3, 4, 5, 7 pole female/male XLR connectors, black plated metal housing, gold plated contacts, REAN plastic package
RC*F-BAG	RC*M-BAG	3, 4, 5, 7 pole female/male XLR connectors, black plated metal housing, silver plated contacts, REAN plastic package
Right-angle XLR		
RC*FR	RC*MR	3, 4, 5, 7 pole female/male right-angle XLR connectors, nickel plated metal housing, silver plated contacts, REAN plastic package
RC*FR-B	RC*M-B	3, 4, 5, 7 pole female/male right-angle XLR connectors, black plated metal housing, gold plated contacts, REAN plastic package
RC*FR-BAG	RC*MR-BAG	3, 4, 5, 7 pole female/male right-angle XLR connectors, black plated metal housing, silver plated contacts, REAN plastic package

Note: Above products provide bulk package with -0 for the article suffix and must be ordered in multiples of 100 pcs

Specification

Electrical	
Contact rated current	10 A (3/4 pole) / 7.5 A (5 pole) / 5 A (7 pole)
Contact resistance	≤ 5 mΩ
Insulation resistance	>1.5 GΩ
Dielectric strength	>1kV dc

Mechanical	
Lifetime	> 1'000 mating cycles
Cable O.D.	4.0 - 7.0 mm
Wiring	Solder contacts
Wiresize (max.)	1.5 mm ² / 16 AWG
Insertion / Withdrawal force	≤ 30 N / ≤ 20 N

Material	
Bushing	PA6+30% GF
Contact	Female: Bronze / Male: Brass
Contact plating	Ag / Au
Insert	PA6+30% GF
Shell	Zinc alloys
Shell plating	Nickel / Black
Strain relief	POM
Button	Zinc alloys
Button plating	Nickel

Environmental	
Temperature range	-20°C to +70°C
Solderability complies with	IEC68-2-20

THE SMART WAY TO CONNECT

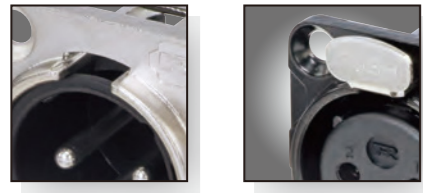

XLR Receptacles



RC3MDL



RC5FDL



RC3FDL-B

- Universal D-size metal shell
- Rugged zinc dieast shell, long-lasting
- Soldered 3, 4, 5 pole receptacles
- Black or nickel plating shell, nickel or gold plating contact
- Rugged latch locking system of female receptacles, provides secure connection

RC*FDL

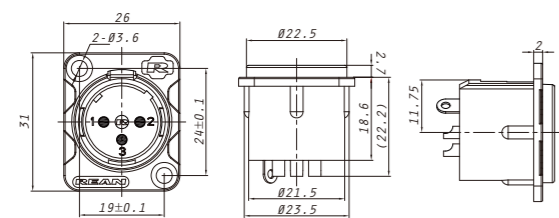

RC*MDL

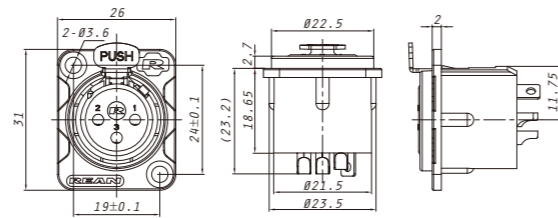

Ordering Information

Article Name	Details
Female	
RC*FDL	3, 4, 5 pole female XLR receptacles, nickel plated housing, tin plated contacts, bulk package
RC*FDL-B	3, 4, 5 pole female XLR receptacles, black plated housing, gold plated contacts, bulk package
Male	
RC*MDL	3, 4, 5 pole male XLR receptacles, nickel plated housing, tin plated contacts, bulk package
RC*MDL-B	3, 4, 5 pole male XLR receptacles, black plated housing, gold plated contacts, bulk package

Specification

Electrical	
Contact rated current	10 A (3/4 pole) / 7 A (5 pole)
Contact resistance	5 mΩ (3/4 pole) / 7 mΩ (5 pole)
Insulation resistance	>1 GΩ
Dielectric strength	>1.5 kV dc

Mechanical	
Lifetime	> 1'000 mating cycles
Insertion force	≤ 20 N
Withdrawal force	≤ 20 N
Locking device	Latch lock (Female)

Material	
Contact	Female: Bronze / Male: Brass
Contact plating	Tin / Au
Insert	PA 6+30% GF
Shell	Zinc alloys
Shell plating	Nickel / Black
Button	65 Mn Steel
Button plating	Nickel

Environmental	
Temperature range	-20 °C to +70 °C
Solderability complies with	IEC68-2-20

THE SMART WAY TO CONNECT



Combo I Series



RCJ9FI-V



RCJ9FI-V-0



RCJ9FI-H-0

- Combined 3 pole XLR and 6.35mm jack - space saving
- Horizontal / vertical PCB mount - conformed to industry standards
- Stereo or mono version
- Full switching product is available
- Latch lock or retention spring version

RCJ9FI-H-0

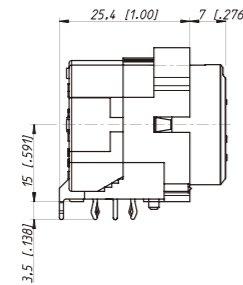
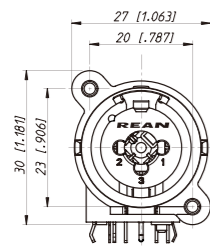

RCJ9FI-V

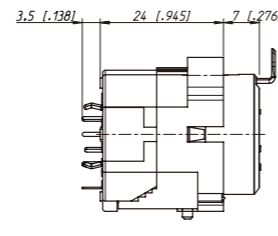
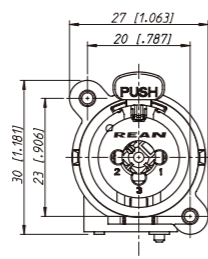

Ordering Information

Article Name	1/4" Jacks	1/4" Switching	PCB Mount	Locking	Bulk Package
Combo I Receptacles					
RCJ6FI-H	TRS	-	Horizontal	Latch Lock	-
RCJ6FI-H-0	TRS	-	Horizontal	Retention Spring	-
RCJ6FI-V	TRS	-	Vertical	Latch Lock	-
RCJ6FI-V-0	TRS	-	Vertical	Retention Spring	-
RCJ9FI-H	TRS	•	Horizontal	Latch Lock	-
RCJ9FI-H-0	TRS	•	Horizontal	Retention Spring	-
RCJ9FI-V	TRS	•	Vertical	Latch Lock	-
RCJ9FI-V-0	TRS	•	Vertical	Retention Spring	-
RCJ10FI-H	TRS	•	Horizontal	Latch Lock	-
RCJ10FI-H-0	TRS	•	Horizontal	Retention Spring	-
RCJ10FI-V	TRS	•	Vertical	Latch Lock	-
RCJ10FI-V-0	TRS	•	Vertical	Retention Spring	-

Specification

Electrical

Contact rated current	7.5 A
Contact resistance	≤ 10 mΩ
Insulation resistance	> 10 GΩ
Dielectric strength	1500 V dc
Rated voltage	50 V ac

Mechanical

Lifetime	> 1'000 mating cycles
Insertion force	≤ 25 N
Withdrawal force	≤ 25 N
Locking device	Latch lock (non -0) Retention Spring (-0)

Material

Contact	Bronze
Contact plating	Ni+Sn+Au Plating
Insert	PA6+30% GF
Shell	PA6+30% GF
Latch lock	Stainless Steel
Latch lock plating	Nickel
Retention spring	Stainless Steel

Environmental

Temperature range	-20 °C to +70 °C
Flammability complies with	UL 94 HB
Solderability complies with	IEC68-2-20



Combo A Series



RCJ6FA-H



RCJ9FA-V



RCJ9FA-H-0

- Combined 3 pole XLR and 6.35mm jack - space saving
- Space saving - 15% over the Combo I Series
- Horizontal / vertical PCB mount
- Latch lock or retention spring version

RCJ9FA-H-0

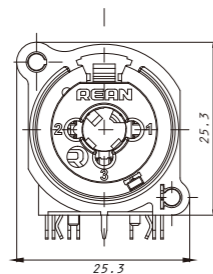
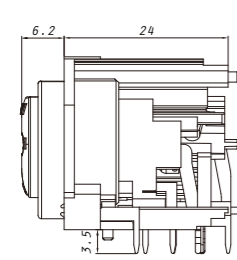

RCJ9FA-V

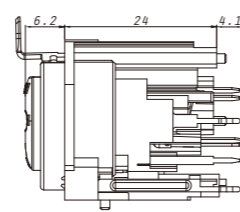
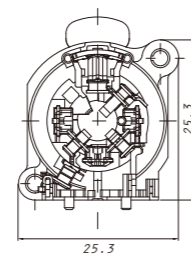

THE SMART WAY TO CONNECT

Ordering Information

Article Name	1/4" Jacks	1/4" Switching	PCB Mount	Locking	Bulk Package
Combo A Receptacles					
RCJ6FA-H	TRS	-	Horizontal	Latch Lock	-
RCJ6FA-H-0	TRS	-	Horizontal	Retention Spring	-
RCJ6FA-V	TRS	-	Vertical	Latch Lock	-
RCJ6FA-V-0	TRS	-	Vertical	Retention Spring	-
RCJ9FA-H	TRS	•	Horizontal	Latch Lock	-
RCJ9FA-H-0	TRS	•	Horizontal	Retention Spring	-
RCJ9FA-V	TRS	•	Vertical	Latch Lock	-
RCJ9FA-V-0	TRS	•	Vertical	Retention Spring	-
RCJ10FA-H	TRS	•	Horizontal	Latch Lock	-
RCJ10FA-H-0	TRS	•	Horizontal	Retention Spring	-
RCJ10FA-V	TRS	•	Vertical	Latch Lock	-
RCJ10FA-V-0	TRS	•	Vertical	Retention Spring	-

Specification

Electrical

Contact rated current	3 A
Contact resistance	≤ 15 mΩ
Insulation resistance	>10 GΩ
Dielectric strength	1500 V dc
Rated voltage	50 V ac

Mechanical

Lifetime	> 1'000 mating cycles
Insertion force	≤ 20 N
Withdrawal force	≤ 20 N
Locking device	Latch lock (non -0) Retention Spring (-0)

Material

Contact	Bronze
Contact plating	Ni+Sn+Au Plating
Insert	PA6+30% GF
Shell	PA6+30% GF
Latch lock	Stainless Steel
Latch lock plating	Nickel
Retention spring	Stainless Steel

Environmental

Temperature range	-20 °C to +70 °C
Flammability complies with	UL 94-V0
Solderability complies with	IEC68-2-20



6.35mm Plugs



RP2C



RP3C-B



RP2RC-BAG

- Rugged Zinc alloy shell - reliable quality
- Chuck type strain relief - excellent cable retention, easy to assembly
- Ergonomic compact right-angle plug - high storage density
- Nickel / gold plated mono / stereo 1/4" plug
- Optional right-angle version

RP2C

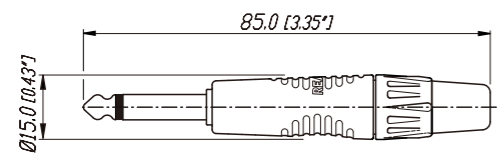

RP3RC

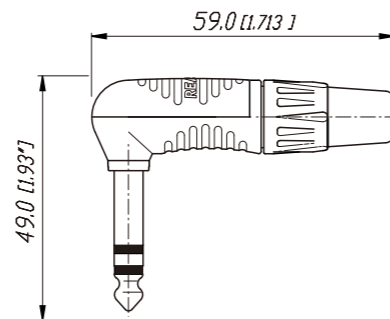

THE SMART WAY TO CONNECT

Ordering Information

Article Name	Details
6.35mm Plugs	
RP2C	Mono 1/4" plug, nickel plated housing, nickel plated contacts, REAN plastic packaging
RP2C-B	Mono 1/4" plug, black plated housing, gold plated contacts, REAN plastic packaging
RP2C-BAG	Mono 1/4" plug, black plated housing, nickel plated contacts, REAN plastic packaging
RP3C	Stereo 1/4" plug, nickel plated housing, nickel plated contacts, REAN plastic packaging
RP3C-B	Stereo 1/4" plug, black plated housing, gold plated contacts, REAN plastic packaging
RP3C-BAG	Stereo 1/4" plug, black plated housing, nickel plated contacts, REAN plastic packaging
RP2RC	Mono 1/4" right-angle plug, nickel plated housing, nickel plated contacts, REAN plastic packaging
RP2RC-B	Mono 1/4" right-angle plug, black plated housing, gold plated contacts, REAN plastic packaging
RP2RC-BAG	Mono 1/4" right-angle plug, black plated housing, nickel plated contacts, REAN plastic packaging
RP3RC	Stereo 1/4" right-angle plug, nickel plated housing, nickel plated contacts, REAN plastic packaging
RP3RC-B	Stereo 1/4" right-angle plug, black plated housing, gold plated contacts, REAN plastic packaging
RP3RC-BAG	Stereo 1/4" right-angle plug, black plated housing, nickel plated contacts, REAN plastic packaging

Note: Above products provide bulk package with -0 for the article suffix and must be ordered in multiples of 100 pcs

Specification

Electrical

Contact rated current	depends on mating connector
Contact resistance	depends on mating connector
Insulation resistance	>1.5 GΩ
Dielectric strength	1kV dc

Mechanical

Lifetime	> 1'000 mating cycles
Cable O.D.	4.0 - 7.0 mm
Wiring	Solder contacts
Wiresize (max.)	1.0 mm ² / 18 AWG

Material

Boot	PA6+30% GF
Contact	Brass (CuZn39Pb3)
Contact plating	Nickel / Au
Shell	Zinc alloy
Shell plating	Nickel / Black
Strain relief	POM

Environmental

Temperature range	-20 °C to +70 °C
Flammability complies with	UL 94 HB
Solderability complies with	IEC68-2-20

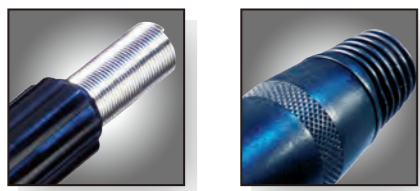

6.35mm Plugs NYS Series



NYS201

NYS204

NYS225

- 6.35mm plug for various engineering applications
- Optional different cable sizes
- Unique design of spring bushing, provide excellent cable protection
- Large taper diecast housing and cable O.D.

NYS201

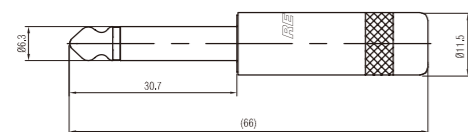

NYS204

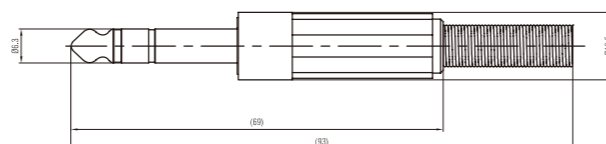

NYS225

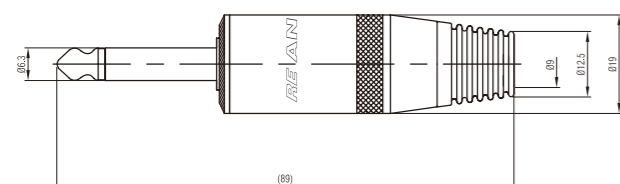

Ordering Information

Article Name	Details
NYS Series	
NYS201	Mono 1/4" plug, diecast metal handle, flexible anti-kink boot protection, REAN plastic package
NYS202	Stereo 1/4" plug, diecast metal handle, flexible anti-kink boot protection, REAN plastic package
NYS203	Mono 1/4" plug, plastic handle, flexible anti-kink boot protection, tail spring, REAN plastic package
NYS204	Stereo 1/4" plug, plastic handle, flexible anti-kink boot protection, tail spring, REAN plastic package
NYS225	Mono 1/4" plug, large metal nickel plated handle for speaker cables, REAN plastic package
NYS225B	Mono 1/4" plug, large metal black plated handle for speaker cables, REAN plastic package
NYS225L	Mono 1/4" plug, large metal nickel plated handle for speaker cables, large cable outlet (10 mm), REAN plastic package
NYS225GS	Mono 1/4" plug, tip switched to ground if not inserted (silent) for guitar cables, REAN plastic package

Specification

Specification	NYS201/202 Series	NYS203/204 Series	NYS225 Series
Electrical			
Contact rated current	depends on mating connector	depends on mating connector	depends on mating connector
Insulation resistance	>1 GΩ	>1 GΩ	>1 GΩ
Dielectric strength	0.5kV dc	0.5kV dc	0.5kV dc

Mechanical

Lifetime	> 1'000 mating cycles	> 1'000 mating cycles	> 1'000 mating cycles
Insertion / Withdrawal force	≤ 60 N	≤ 60 N	≤ 60 N
Cable O.D.	≤ 8.5 mm	≤ 6.5 mm	≤ 10 mm

Material

Boot	POM	POM	POM
Sleeve & Inner	Zinc alloy	Zinc alloy	Zinc alloy
Sleeve plating	Nickel	Nickel	Nickel
Inner plating	Nickel	Nickel	Nickel
Shell	Zinc diecast (ZnAl4Cu1)	ABS	Zinc diecast (ZnAl4Cu1)
Shell plating	Nickel	Nickel / Black	Nickel / Black
Bushing	Polyamides	Polyamides	Polyamides
Cable Clamp	Steel	Steel	Steel
Spring	-	High quality spring steel	-

Environmental

Temperature range	-20 °C to +70 °C
Flammability complies with	UL 94 HB
Solderability complies with	IEC68-2-20



6.35mm Plugs NYS Series

Pancake



NYS224



NYS207-2



RP2RCF

- 6.35mm plug for engineering applications
- Right-angle plugs with (red / black) polyamides cover for selection
- Optional different plating for housing, contact, sleeves
- Optional different cable sizes

- Uniqed mono right-angle plug
- Pan head - space saving design for engineering applications
- Optional bickel / black plated housing
- Optional black / white Logo

NYS224

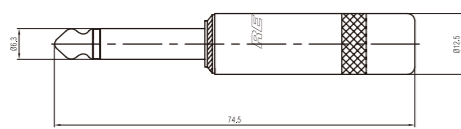

NYS224

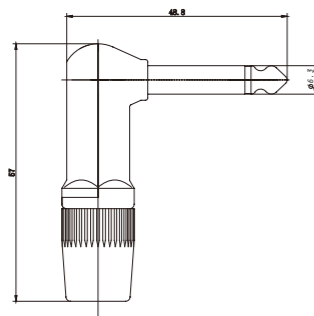

RP2RCF

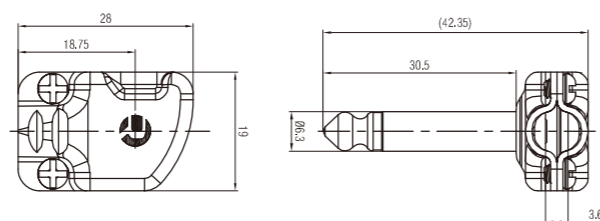

Ordering Information

Article Name	Details
NYS Series	
NYS224	Mono 1/4" plug, long diecast nickel plated handle
NYS224G	Mono 1/4" plug, long diecast nickel plated handle, gold plated sleeve and inner
NYS224AG	Mono 1/4" plug, long diecast gold plated handle, gold plated sleeve and inner
NYS224BG	Mono 1/4" plug, long diecast black plated handle, gold plated sleeve and inner
NYS224GT	Mono 1/4" plug, long diecast nickel plated handle, gold plated sleeve and inner
NYS224L	Mono 1/4" plug, long diecast nickel plated handle, large cable outlet (9.5 mm)
NYS224S	Mono 1/4" plug, long diecast nickel plated handle, tip switched to ground if not inserted (silent)
NYS228	Stereo 1/4" plug, long diecast nickel plated handle
NYS228G	Stereo 1/4" plug, long diecast nickel plated handle, gold plated sleeve and inner
NYS228BG	Stereo 1/4" plug, long diecast black plated handle, gold plated sleeve and inner
NYS228GT	Stereo 1/4" plug, long diecast nickel plated handle, gold plated inner
NYS207	Mono 1/4" right-angle plug, nickel plated handle, black plastic cover and bushing, provide red cover (nys207-2)
NYS208	Stereo 1/4" right-angle plug, nickel plated handle, black plastic cover and bushing, provide red cover (nys208-2)

Note: Above products are provided in REAN plastic package

Pancake

RP2RCF	Mono 1/4" right-angle plug, pan head, nickel plated handle, REAN plastic packaging
RP2RCF-BAG	Mono 1/4" right-angle plug, pan head, black plated handle, REAN plastic packaging

Note: Pancake products provide bulk package with -0 for the article suffix and must be ordered in multiples of 100 pcs

Specification

Specification	NYS207/208 Series	NYS224/228 Series	Pancake Series
Electrical			
Contact rated current	depends on mating connector	depends on mating connector	depends on mating connector
Insulation resistance	>1 GΩ	>1 GΩ	>1 GΩ
Dielectric strength	0.5kV dc	0.5kV dc	0.5kV dc

Mechanical

Lifetime	> 1'000 mating cycles	> 1'000 mating cycles	> 1'000 mating cycles
Insertion / Withdrawal force	≤ 60 N	≤ 60 N	≤ 60 N
Cable O.D.	≤ 7.5 mm	≤ 9.5 mm	4 - 7 mm
Wiresize			

Material

Boot	POM	POM	-
Sleeve & Inner	Brass	Brass	Brass
Sleeve plating	Nickel	Nickel / Au	Nickel / Au
Inner plating	Nickel	Nickel / Au	Nickel / Au
Shell	Zinc alloy, red/black polyamides cover	Zinc alloy	Steel
Shell plating	Nickel	Nickel / Black	Nickel / Black
Bushing	Polyamides	-	-
Cable Clamp	Steel	Steel	-

Environmental

Temperature range	-20 °C to +70 °C
Flammability complies with	UL 94 HB
Solderability complies with	IEC68-2-20

THE SMART WAY TO CONNECT

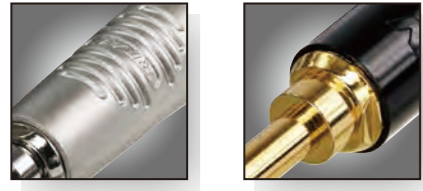

3.5 mm Plugs



- Ergonomic space saving design
- Full metal rugged shell, reliable quality
- Easy to assembly and use
- Optional mono 2 pole and stereo 3 pole
- Max. cable O.D. up to 8.5mm

RTP2C

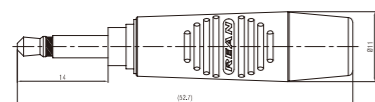

RTP3C

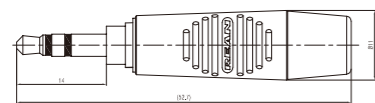

NYS226

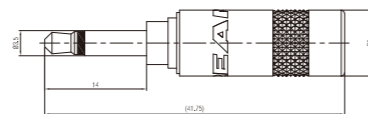

NYS231

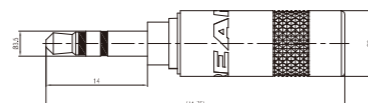

Ordering Information

Article Name	Details
3.5mm Plugs	
RTP*C	3.5mm mono / stereo plug, nickel plated handle, nickel plated sleeve and inner, REAN plastic packaging
RTP*C-B	3.5mm mono / stereo plug, black plated handle, gold plated sleeve and inner, REAN plastic packaging
RTP*C-BAG	3.5mm mono / stereo plug, black plated handle, nickel plated sleeve and inner, REAN plastic packaging
Note: *2/3, above products provide bulk package with -0 for the article suffix and must be ordered in multiples of 100 pcs	
NYS226	3.5mm mono plug, nickel plated handle, nickel plated sleeve and inner, REAN plastic packaging
NYS226B	3.5mm mono plug, black plated handle, nickel plated sleeve and inner, REAN plastic packaging
NYS226BG	3.5mm mono plug, black plated handle, gold plated sleeve and inner, REAN plastic packaging
NYS226G	3.5mm mono plug, nickel plated handle, gold plated sleeve and inner, REAN plastic packaging
NYS226L	3.5mm mono plug, nickel plated handle, nickel plated sleeve and inner, large cable outlet, REAN plastic packaging
NYS231	3.5mm stereo plug, nickel plated handle, nickel plated sleeve and inner, REAN plastic packaging
NYS231B	3.5mm stereo plug, black plated handle, nickel plated sleeve and inner, REAN plastic packaging
NYS231BG	3.5mm stereo plug, black plated handle, gold plated sleeve and inner, REAN plastic packaging
NYS231G	3.5mm stereo plug, nickel plated handle, gold plated sleeve and inner, REAN plastic packaging
NYS231L	3.5mm stereo plug, nickel plated handle, nickel plated sleeve and inner, large cable outlet, REAN plastic packaging
NYS231LBG	3.5mm stereo plug, black plated handle, gold plated sleeve and inner, large cable outlet, REAN plastic packaging
NYS231LL	3.5mm stereo plug, nickel plated handle, nickel plated sleeve and inner, x-large cable outlet, REAN plastic packaging
NYS231BG-LL	3.5mm stereo plug, black plated handle, gold plated sleeve and inner, x-large cable outlet, REAN plastic packaging

Specification

	RTP*C Series	NYS226/231 Series
Electrical		
Contact rated current	depends on mating connector	depends on mating connector
Insulation resistance	≥ 1.5 GΩ	≥ 1.5 GΩ
Dielectric strength	1kV dc	1kV dc
Mechanical		
Lifetime	> 1'000 mating cycles	> 1'000 mating cycles
Insertion / Withdrawal force	≤ 60 N	≤ 60 N
Cable O.D.	2-6 mm	2-8.5 mm
Material		
Boot	PVC	-
Sleeve & Inner	Brass	Brass
Sleeve plating	Nickel / Au	Nickel / Au
Inner plating	Nickel / Au	Nickel / Au
Shell	Zinc alloy	Zinc alloy
Shell plating	Nickel / Black	Nickel / Black
Bushing	Polyamides	Polyamides
Cable Clamp	Steel	Steel

Environmental

Temperature range	-20 °C to +70 °C
Flammability complies with	UL 94 HB
Solderability complies with	IEC68-2-20

THE SMART WAY TO CONNECT

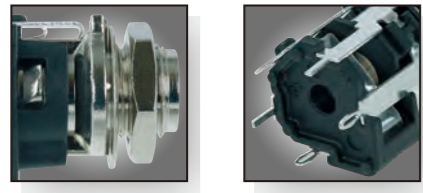

6.35mm Vertical Jacks



RJ3VM



RJ3VI-S



RJ5VM

- 6.35mm vertical PCB mountable jack
- Knob mounting nut, less product assembly time
- Spring-loaded ground contact, excellent contact integrity
- Optional metal / plastic thread
- High density compact product design, space saving

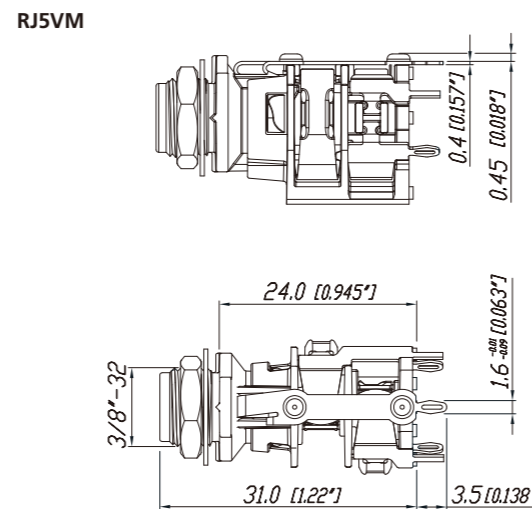
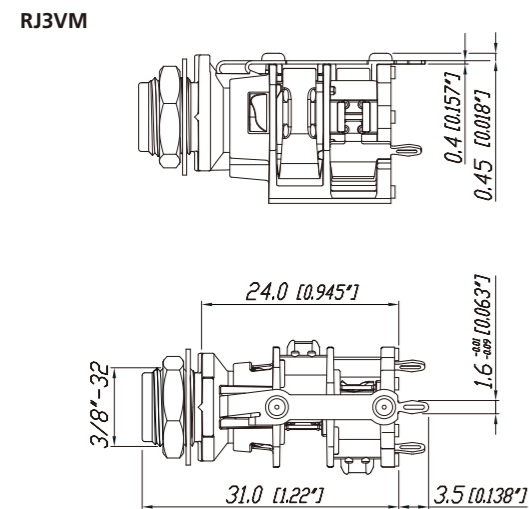

Ordering Information

Article Name	Details
6.35mm Vertical Jacks	
RJ3VM	6.35mm mono jack, black plastic housing, metal nose, vertical PCB contacts, bulk package
RJ3VM-D1	6.35mm mono jack, black plastic housing, metal nose, vertical D1 PCB contacts, bulk package
RJ3VM-S	6.35mm mono jack, black plastic housing, metal nose, solder lugs, bulk package
RJ3VI	6.35mm mono jack, black plastic housing, plastic nose, vertical PCB contacts, bulk package
RJ3VI-D1	6.35mm mono jack, black plastic housing, plastic nose, vertical D1 PCB contacts, bulk package
RJ3VI-S	6.35mm mono jack, black plastic housing, solder lugs, bulk package
RJ5VM	6.35mm stereo jack, normalling contacts, black plastic housing, metal nose, vertical PCB contacts, bulk package
RJ5VM-D1	6.35mm stereo jack, normalling contacts, black plastic housing, metal nose, vertical D1 PCB contacts, bulk package
RJ5VM-S	6.35mm stereo jack, normalling contacts, black plastic housing, solder lugs, bulk package
RJ5VI	6.35mm stereo jack, normalling contacts, black plastic housing, plastic nose, vertical PCB contacts, bulk package
RJ5VI-D1	6.35mm stereo jack, normalling contacts, black plastic housing, plastic nose, vertical D1 PCB contacts, bulk package
RJ5VI-S	6.35mm stereo jack, normalling contacts, black plastic housing, solder lugs, bulk package

Specification

Electrical	
Contact rated current	3 A
Contact resistance	< 10 mΩ
Insulation resistance	≥ 1 GΩ
Dielectric strength	500 V dc

Mechanical	
Lifetime	> 1'000 mating cycles
Insertion force	≤ 20 N
Withdrawal force	≥ 10 N

Material	
Contact	Bronze
Contact plating	Ag
Shell	PA6+30% GF
Thread nose	Plastic / Zinc alloy
Washer	CRS(Cold Rolled Steel)

Environmental	
Temperature range	-20 °C to +70 °C
Solderability complies with	IEC68-2-20

THE SMART WAY TO CONNECT



6.35mm Horizontal Jacks



NYS212

NYS215

NYS216H

NYS219

- 6.35mm horizontal PCB mountable jack
- Provide mono / stereo version
- Various pin lengths and types, meet different application requirements
- Optional metal / plastic threaded nose

NYS212

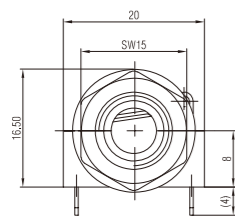

NYS219

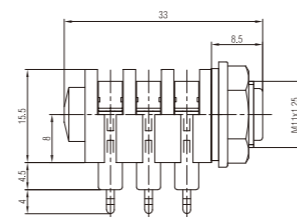
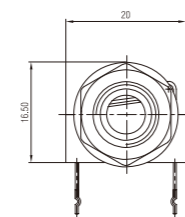
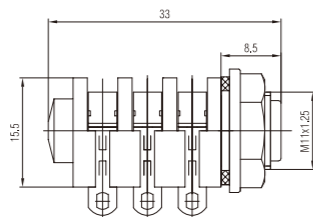

Ordering Information

Article Name	Details
6.35mm Horizontal Jacks	
NYS212	6.35mm stereo jack, black plastic housing with washer and nut, solder taps, normalling contacts
NYS2122	6.35mm mono jack, black plastic housing with washer and nut, solder taps, normalling contacts
NYS216	6.35mm stereo jack, black plastic housing with washer and nut, 8.2 mm distance to PCB
NYS216G	6.35mm stereo jack, black plastic housing with washer and nut, gold plated contacts, 8.2 mm distance to PCB
NYS216H	6.35mm stereo jack, black plastic housing with washer and nut, half threaded nose, 8.2 mm distance to PCB
NYS2162	6.35mm mono jack, black plastic housing with washer and nut, 8.2 mm distance to PCB
NYS2162H	6.35mm mono jack, black plastic housing with washer and nut, half threaded nose, 8.2 mm distance to PCB
NYS215	6.35mm stereo jack, black plastic housing, metal nut, two brown washers, 8.2 mm distance to PCB
NYS2152	6.35mm mono jack, black plastic housing, metal nut, two brown washers, 8.2 mm distance to PCB
NYS2152G	6.35mm mono jack, black plastic housing, gold plated contacts, metal nut, two brown washers, 8.2 mm distance to PCB
NYS2152G-DI-U	6.35mm mono jack, black plastic housing, gold plated contacts, metal nut, two brown washers, solder tap version
NYS219	6.35mm stereo jack, black plastic housing, long contacts, 12.5 mm distance to PCB
NYS2192	6.35mm mono jack, black plastic housing, long contacts, 12.5 mm distance to PCB

Note: Above products are provided in bulk package

Specification

Electrical

Contact rated current	3 A
Contact resistance	≤ 10 mΩ
Insulation resistance	> 2000 mΩ (initial)
Dielectric strength	500 V dc

Mechanical

Lifetime	> 5'000 mating cycles
Insertion force	≤ 20 N
Withdrawal force	≥ 10 N

Material

Contact	Bronze
Contact plating	Ag / Au
Shell	PA6+30% GF
Thread nose	Plastic / Zinc alloy
Washer	PA6+15% GF / Epoxy plate

Environmental

Temperature range	-20 °C to +70 °C
Solderability complies with	IEC68-2-20



6.35 mm Jacks



Metal Jacks

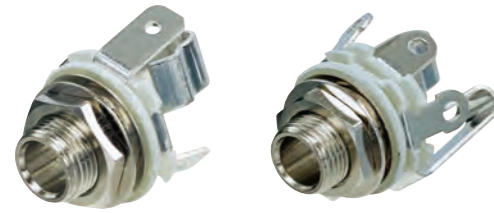

NYS229

NYS230



NYS2203

NYS240

- 6.35mm jacks, panel mountable
- Provide mono / stereo version
- Precision machined thread, nut and screw close combination
- Adapt various panel thickness

- 6.35mm / 3.5mm stereo metal jacks
- Simple design, easy installation
- Full metal design for engineering use

NYS229

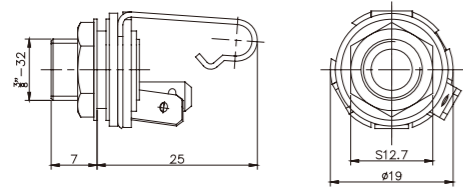

NYS2203

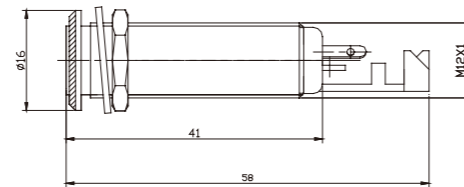

NYS230

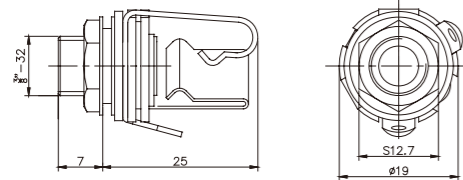

NYS240

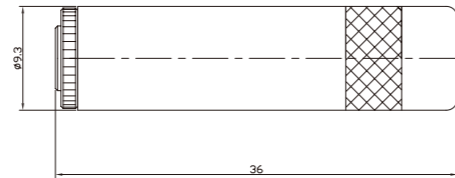

Ordering Information

Article Name	Details
6.35mm Jacks	
NYS229	6.35mm mono open jack, with washer and nut, 0.205" faston tabs, for up to 3.5 mm panel thickness
NYS229L	6.35mm mono open jack, with washer and nut, 0.205" faston tabs, for up to 6.5 mm panel thickness
NYS230	6.35mm stereo open jack, with washer and nut, 0.205" faston tabs, for up to 3.5 mm panel thickness
Note: Above products are provided in bulk package	
Metal Jacks	
NYS221	6.35mm stereo jack, long-threaded bushing with washer and nut, full metal design, bulk package
NYS2202	6.35mm mono jack, long-threaded bushing with washer and nut, full metal design, REAN plastic package
NYS2203	6.35mm stereo jack, long-threaded bushing with washer and nut, full metal design, REAN plastic package
NYS2202P	6.35mm mono jack, metal handle, max. cable O.D. 6 mm, REAN plastic package
NYS2203P	6.35mm stereo jack, metal handle, max. cable O.D. 6 mm, REAN plastic package
NYS240	3.5mm stereo jack, metal handle, max. cable O.D. 4 mm, REAN plastic package
NYS240BG	3.5mm stereo jack, black metal handle, gold plated contacts, max. cable O.D. 4 mm, REAN plastic package
NYS240L	3.5mm stereo jack, metal handle, max. cable O.D. 6 mm, REAN plastic package

Specification

Specification	NYS229/230 Series	NYS221/2202 Series	NYS240
Electrical			
Contact rated current	3 A	3 A	3 A
Contact resistance	< 10 mΩ	< 10 mΩ	< 10 mΩ
Insulation resistance	> 2000 mΩ (initial)	> 2000 mΩ (initial)	> 2000 mΩ (initial)
Dielectric strength	500 V dc	500 V dc	500 V dc

Mechanical

Lifetime	> 5'000 mating cycles	> 5'000 mating cycles	> 5'000 mating cycles
Insertion force	≤ 20 N	≤ 20 N	≤ 20 N
Withdrawal force	≥ 10 N	≥ 10 N	≥ 10 N

Material

Contact	Bronze	Bronze	Bronze
Contact plating	Tin	Tin	Tin / Au
Shell	Brass	Brass	Zinc alloy
Thread nose	Brass	Brass	Brass
Washer	Steel	Steel	-

Environmental

Temperature range	-20 °C to +70 °C
Solderability complies with	IEC68-2-20

THE SMART WAY TO CONNECT

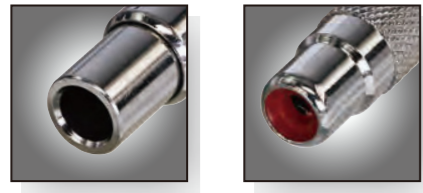

Adapters



NYS227

NYS355

NYS236

NYS239

- Various range of converter products, meet the needs of different connectors
- Provide 6.35mm mono/stereo plug - plug and jack - jack adapters
- Optional 6.35mm stereo plug - 3.5mm jack adapters
- Unique phono adapters, easy to operate
- Full metal shell design, increase the mating cycles, prolong lifetime

NYS227



NYS355

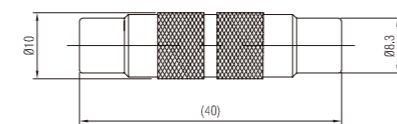

NYS236

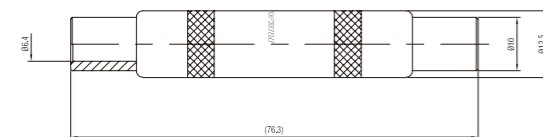

Ordering Information

Article Name	Details
Adapters	
NYS227	3.5mm stereo plug - 6.35mm plug adapter, full metal, REAN plastic package
NYS236	6.35mm mono jack - 6.35mm mono jack adapter, full metal, REAN plastic package
NYS237	6.35mm mono plug - 6.35mm mono plug adapter, full metal, REAN plastic package
NYS238	6.35mm stereo jack - 6.35mm stereo jack adapter, full metal, REAN plastic package
NYS239	6.35mm stereo plug - 6.35mm stereo plug adapter, full metal, REAN plastic package
NYS355	Phono jack - jack adapter, full metal, REAN plastic package

Specification

Electrical

Contact resistance	< 10 mΩ
Insulation resistance	> 2000 mΩ (initial)
Dielectric strength	50Hz 500VAC

Mechanical

Lifetime	> 1'000 mating cycles
Insertion force	≤ 20 N
Withdrawal force	≥ 10 N

Material

Shell	Bronze
Contact	Brass

Environmental

Temperature range	-20 °C to +70 °C
Solderability complies with	IEC68-2-20

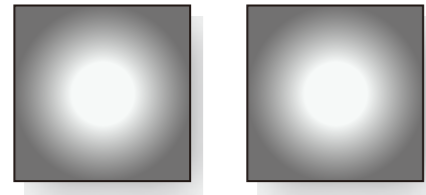

RCA Plugs / Jacks



RF2C-AU-0

NYS352

NYS373-2

NYS367-4

- High quality RCA plugs and jacks, precision processing
- Color code ring and color bushing for channel identification
- Optional gold plated contact products, ensure the stability of signal transmission
- Ergonomic product design, easy to operate
- Plastic or metal shell products, meet various needs

RF2C-*

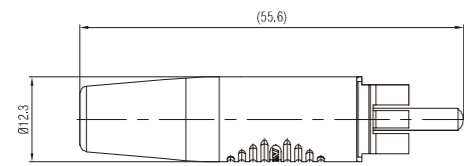

NYS373

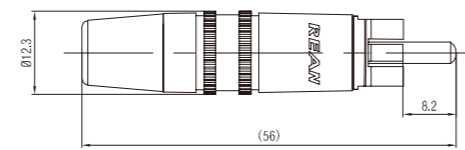

NYS352

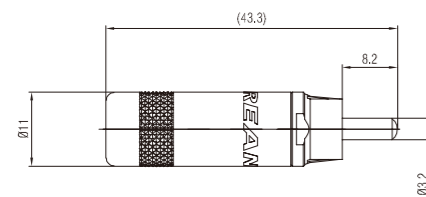

NYS367

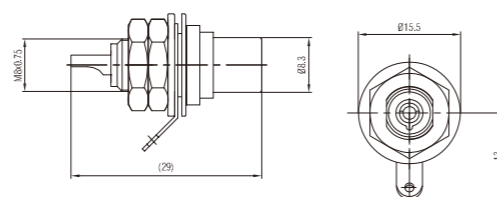

Ordering Information

Article Name	Details
RCA Plugs / Jacks	
RF2C-AU-0	RCA phono plug, nickel plated shell, gold plated contacts, black boot, REAN plastic packaing
RF2C-AU-2	RCA phono plug, nickel plated shell, gold plated contacts, red boot, REAN plastic packaing
RF2C-B-0	RCA phono plug, black plated shell, gold plated contacts, black boot, REAN plastic packaing
RF2C-B-2	RCA phono plug, black plated shell, gold plated contacts, red boot, REAN plastic packaing
NYS352	Heavy duty phono plug, nickel plated shell, nickel plated contacts
NYS352AG	Heavy duty phono plug, gold plated shell, nickel plated contacts
NYS352B	Heavy duty phono plug, black plated shell, nickel plated contacts
NYS352BG	Heavy duty phono plug, black plated shell, gold plated contacts
NYS352G	Heavy duty phono plug, nickel plated shell, gold plated contacts
NYS373-0	Phono plug, black shell, black color coding, gold plates contacts, rubber anti-kink boot, chuck type strain relief, cable O.D. 3.5 - 6.1 mm
NYS367-0	Phono plug, gold plated contacts, black color coding

Note: 1) color coding for NYS367/373 series

0	2	4	5	6	9
Black	Red	Yellow	Green	Blue	White

 2) NYS367/373 series are provided in REAN plastic package

Specification

Electrical

Rated voltage	depends on mating connector
Contact resistance	depends on mating connector
Insulation resistance	> 2000 mΩ (initial)
Dielectric strength	500 V dc

Mechanical

Lifetime	> 1'000 mating cycles
Insertion force	≤ 20 N
Withdrawal force	≥ 10 N

Material

Contact	Bronze
Contact plating	Ag / Au / Nickel
Shell	Zinc alloy
Shell plating	Nickel / Black
Boot	PVC
Cable clamp	Steel / POM
Insert	Brass
Lug	Brass

Environmental

Temperature range	-20 °C to +70 °C
Solderability complies with	IEC68-2-20



Loudspeaker Connectors



RLS4FC



RLS4MPZ



RLS4MDZ-H

THE SMART WAY TO CONNECT

- Using fiberglass material, rugged insert and shell
- Solid keyway, reliable and suitable
- Robust lock system, safe locking
- Chuck type strain relief, maximum cable capacity, quick and convenient installation
- Sealed design, model types in the speaker connector application field

RLS4FC

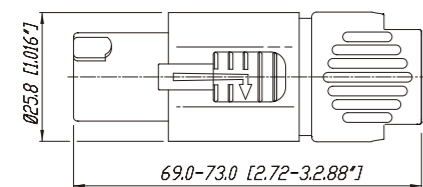

RLS4MPZ

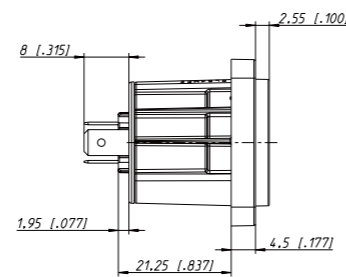
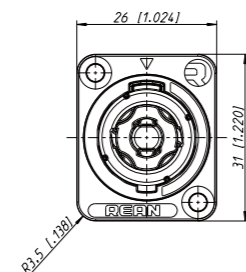

RLS4MDZ-H

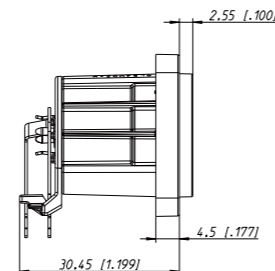
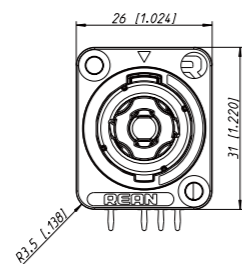

Ordering Information

Article Name	Details
--------------	---------

Cable Connectors

RLS4FC	4 pole loudspeaker cable connector with latch lock, chuck type strain relief, REAN plastic package
--------	--

Receptacles

RLS4MDZ-H	4 pole loudspeaker receptacle, D-Size front horizontal mounted, PCB contacts, REAN plastic package
RLS4MDZ-V	4 pole loudspeaker receptacle, D-Size front vertical mounted, PCB contacts, REAN plastic package
RLS4MPZ	4 pole loudspeaker receptacle, D-Size front mounted, solder cup contacts, REAN plastic package

Specification	Cable connectors RLS4FC	Receptacles RLS4MDZ-*/RLS4MPZ
---------------	----------------------------	----------------------------------

Electrical

Contact rated current	continuous 30 A rms	continuous 30 A rms
Contact resistance	≤ 5 mΩ	≤ 5 mΩ
Insulation resistance	>1 GΩ	>1 GΩ
Dielectric strength	4kV dc	4kV dc
Rated voltage	250 V	250 V

Attention: Cable connectors and receptacles are not to be used as an AC mains or power supply connector!

Mechanical

Lifetime	> 1'000 mating cycles	> 1'000 mating cycles
Chassis type	-	D
Cable O.D.	6.5 -10 mm	-
Wiring	Screw	flat tab (4.8 × 0.5 mm) or soldering
Locking device	Quick Lock	-
Mounting direction	-	Front or rear mounting

Material

Contact	Brass	Bronze
Contact plating	Ag	Ag
Insert	PBT	-
Shell	PA6+30% GF	PA6+30% GF
Strain relief	POM	-
Locking element	Zinc alloy	-
Boot	PA6+30% GF	-

Environmental

Temperature range	-30 °C to +80 °C	-30 °C to +80 °C
Flammability	UL 94-V0	UL 94-V0
Solderability complies with	-	IEC68-2-20



Power Connectors



RCAC31-G-000

RRAC31-G-000

RCAC30-G-000

RRAC30-G-000

- High current capacity, rated at 20A / 250V ac
- Rugged twist lock system, ergonomic quick lock design
- Color coding divided, power-in and power-out versions with different keying, avoid the possibility of intermating
- UL recognized components
- Chuck type strain relief, reliable cable capacity

RCAC31-G / RCAC30-G

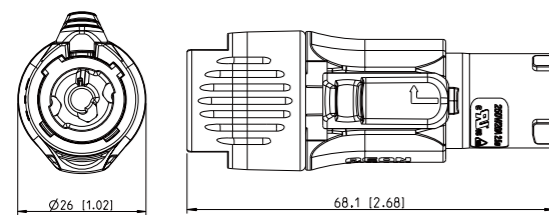

RRAC31-G / RRAC30-G

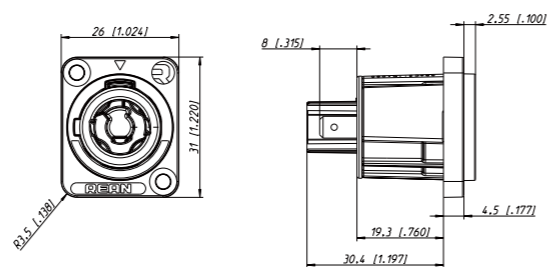

Ordering Information

Article Name	Details
Power Connectors	
RCAC31-G-000	Cable connector, blue housing, twist lock, screw type terminals, power inlet
RRAC31-G-000	Receptacle, blue housing, air tight design, flat tabs or soldering terminals, power inlet
RCAC30-G-000	Cable connector, grey housing, twist lock, screw type terminals, power outlet
RRAC30-G-000	Receptacle, grey housing, air tight design, flat tabs or soldering terminals, power outlet

Note: Above products are bulk packaged with -0 for the article suffix and must be ordered in multiples of 100 pcs

Specification	Cable connectors	Receptacles
Electrical		
Number of contacts	2 + PE	2 + PE
Rated current per contact	20 A rms	20 A rms
Rated Voltage	250 V	250 V
Dielectric strength	4 kV ac	4 kV ac
Contact resistance	≤ 3 mΩ	≤ 3 mΩ
Insulation resistance (after dampheat)	>0.1 GΩ	>0.1 GΩ

Mechanical		
Retention method	Twist lock	Twist lock
Cable O.D.	6 - 15 mm	6 - 15 mm
Wiring	Screw type terminals or soldering	Flat tabs (4.8 x 0.5 mm) or soldering
Wiresize: 2.5 mm ² / 14 AWG		

Material		
Shell	HC polymer HB	HC polymer HB
Insert	PA6+30% GF	PA6+30% GF
Contact	Brass	Bronze
Contact plating	Ag	Ag
Strain relief	POM	POM

Environmental	
Temperature range	-30 °C to +80 °C
Solderability complies with	IEC68-2-20

THE SMART WAY TO CONNECT



Power Connectors - Outdoor X Series



- True mains connector with breaking capacity (CBC)
- Complete system with inlet and outlet connectors
- Designed to be engaged and disengaged in normal use when live or under load
- IP 65 rating outdoor protection
- Anti-kink boot design, according to IEC 60320
- Easy and reliable twist lock system
- Using V0 materials, good flame retardant property

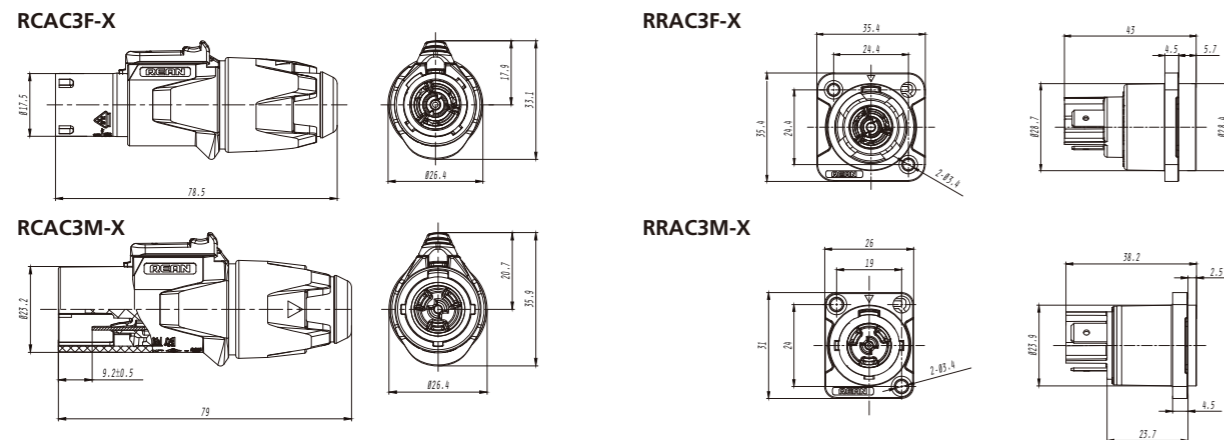

Ordering Information

Article Name	Details
Cable Connectors	
RCAC3F-X-000	Lockable cable connector, power inlet, screw type terminals, IP65 rating
RCAC3M-X-000	Lockable cable connector, power outlet, screw type terminals, IP65 rating
Receptacles	
RRAC3F-X-000	Receptacle, 1/4" flat tabs, power outlet
RRAC3M-X-000	Receptacle, 1/4" flat tabs, power inlet

Note: Above products are bulk packaged with -0 for the article suffix, plastic bag with -1 and must be ordered in multiples of 100 pcs

Accessories



Specification

Electrical	Cable connectors	Receptacles
Number of contacts	2 + PE	2 + PE
Rated current per contact	20 A rms ¹⁾	20 A rms ¹⁾
Rated Voltage	250 V ac	250 V ac
Dielectric strength	4 kV dc / 2.8 kV ac	4 kV dc / 2.8 kV ac
Contact resistance	≤ 2 mΩ	≤ 2 mΩ
Insulation resistance (after dampheat)	>0.1 GΩ	>1 GΩ

Mechanical

Retention method	Twist lock	Twist lock
Lifetime	> 5'000 mating cycles	> 5'000 mating cycles
Cable O.D.	6 - 12 mm	-
Wiring	Screw type terminals	Flat tabs (4.8 x 0.5 mm)
	Wiresize: 1.0 - 2.5 mm ² / 12 AWG	-

Material

Shell	Polyamide	Polyamide
Insert	Polyamide	Polyamide
Contact	Copper alloy	Copper alloy
Contact plating	Ag	Ag
Strain relief	PBT	-

Environmental

Temperature range	-30 °C to +80 °C
Flammability complies with	UL 94 V0

¹⁾ : Appliance coupler acc. IEC 60320 limited to 16 A ac

THE SMART WAY TO CONNECT



Ethernet Connectors

Receptacles



RE8MY-1



RRE8F-D-001

THE SMART WAY TO CONNECT

- Cable carrier accepts the most common RJ45 plugs
- Industrial application design, provide protection for the fragile RJ45 to ensure stable connection
- Chrome / black plated housing
- Cable connectors do not include a RJ45 plug

- CAT5e according to ISO/IEC 11801 and TIA/EIA 568B
- D shape flange
- Rugged latch lock system
- Vertical PCB mount

RE8MY-1

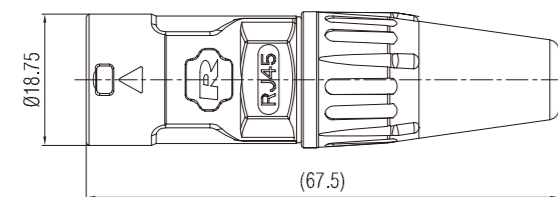

RRE8F-D-001

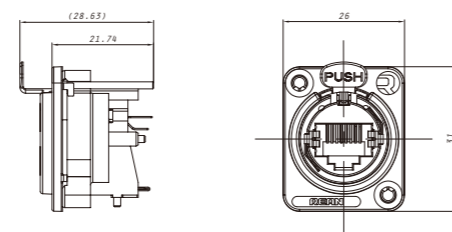

Ordering Information

Article Name	Details
RJ45 Cable Carriers	
RE8MY-1	Cable carrier, do not include RJ45 plug, chrome plated housing
RE8MY-1-B	Cable carrier, do not include RJ45 plug, black plated housing

RJ45 Receptacles	
RRE8F-D-001	Rugged RJ45 receptacles, D shape mental flange, vertical PCB mount, latch lock

Note: Above products are bulk packaged with -0 for the article suffix and must be ordered in multiples of 100 pcs

Specification

Electrical	Cable Carriers	Receptacles
Contact resistance	-	≤ 10 mΩ
Dielectric strength	-	1kV dc
Frequency bandwidth	-	1 – 100 MHz
Insulation resistance	-	> 0.5 GΩ
Rated current per contact	-	1.5 A
Rated Voltage	-	< 50 V
Transmission performance	-	CAT 5e

Mechanical

Lifetime	> 1'000 mating cycles	> 2'000 mating cycles
Insertion / Withdrawal force	≤ 20 N	≤ 20 N
Cable O.D.	4.0 - 8.0 mm	Panel thickness max. 4 mm 0.16'
Wiring	-	Vertical PCB mount
Locking device	-	Latch lock
Mounting direction	-	Front mounting
Chassis shape	-	D
Power over Ethernet	-	PoE+ acc. IEEE 802.3at

Material

Shell	Zinc alloy	Zinc alloy
Shell plating	Chrome / Black	Black
Strain relief	POM	-
Contact	-	Bronze
Contact plating	-	Au
Insert	-	PBTP 15 % GR
Locking element	-	Zinc diecast
Button	-	65 Mn Steel
Button plating	-	Nickel

Environmental

Flammability	UL 94 V-0
Standard compliance	TIA/EIA 586B, IEC 11801
Temperature range	-30 °C to +80 °C

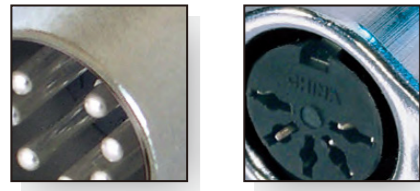

DIN Connectors



NYS323



NYS325

- Conformed to standard multi-pin connector series
- Unbalanced line inputs and outputs for device ports
- Optional gold plated housing and contacts
- Provide 3, 5, 7 pole version

NYS323

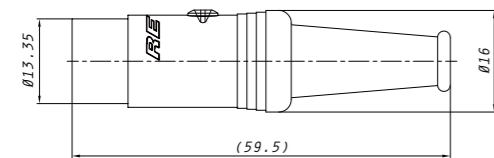

NYS325

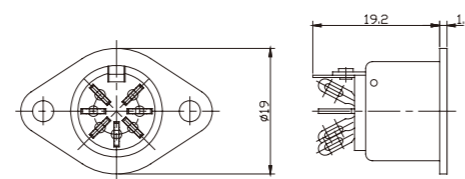

Ordering Information

Article Name	Details
DIN Connectors	
NYS321	3 pole DIN cable connector, male, nickel plated housing, silver plated contacts, REAN plastic package
NYS321G	3 pole DIN cable connector, male, nickel plated housing, gold plated contacts, REAN plastic package
NYS322	5 pole DIN cable connector, male, nickel plated housing, silver plated contacts, REAN plastic package
NYS322G	5 pole DIN cable connector, male, nickel plated housing, gold plated contacts, REAN plastic package
NYS322AG	5 pole DIN cable connector, male, gold plated housing, gold plated contacts, REAN plastic package
NYS323	7 pole DIN cable connector, male, nickel plated housing, silver plated contacts, REAN plastic package
NYS323G	7 pole DIN cable connector, male, nickel plated housing, gold plated contacts, REAN plastic package

DIN Receptacles

NYS324	3 pole DIN receptacles, female, nickel plated housing, silver plated contacts, bulk package
NYS325	5 pole DIN receptacles, female, nickel plated housing, silver plated contacts, bulk package
NYS326	7 pole DIN receptacles, female, nickel plated housing, silver plated contacts, bulk package

Specification

Specification	DIN Cable connectors	DIN Receptacles
Electrical		
Number of contacts	3 / 5 / 7	3 / 5 / 7
Contact resistance	≤ 10 mΩ	≤ 10 mΩ
Insulation resistance (initial)	>1000 MΩ	>1000 MΩ
Rated Voltage	50 V ac	50 V ac
Withstand Voltage	0.5kV dc	0.5kV dc

Mechanical

Lifetime	> 1'000 mating cycles	> 1'000 mating cycles
Insertion force	≤ 24 -56 N	≤ 24 -56 N
Withdrawal force	> 3 - 7.5 N	> 3 - 7.5 N
Separation force per contact	> 120 N	> 120 N

Material

Shell	Zinc alloy	High-Quality Steel
Shell plating	Nickel / Au	Nickel
Contact	Brass	Bronze
Contact plating	Ag / Au	Ag
Insert	PA6+30% GF	PA6+30% GF
Strain relief	PVC	-

Environmental

Temperature range	-30 °C to +85 °C
Solderability complies with	IEC68-2-20

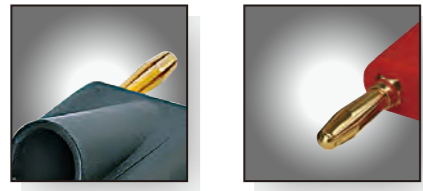

Dual banana plug



NYS508-B



NYS508-R

- Standard dual banana plug for high power output devices
- Gold plated contacts, ensure perfect transmission performance
- Optional black / red housing

NYS5508-B

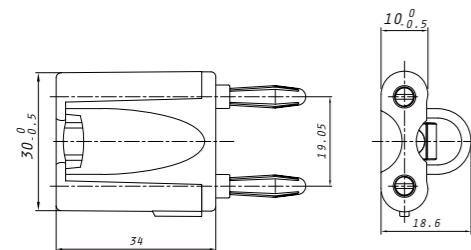

THE SMART WAY TO CONNECT

Ordering Information

Article Name	Details
Dual Banana Plug	
NYS508-B	Dual Banana Plug, cable O.D. 6.0 - 10.5 mm, gold plated contacts, black, bulk package
NYS508-R	Dual Banana Plug, cable O.D. 6.0 - 10.5 mm, gold plated contacts, red, bulk package

Specification

Electrical	
Contact resistance	≤ 10 mΩ
Insulation resistance (initial)	> 1000 MΩ
Dielectric strength	500V dc
Rated Voltage	50 Vac

Mechanical	
Lifetime	> 1'000 mating cycles
Insertion force	≤ 56 N
Withdrawal force	> 7.5 N

Material	
Contact	Bronze
Contact plating	Au
Shell	PA6+30%GF
Shell color	Black / Red / Customize
Retainers	PA6+30%GF
Nut	Steel
Nut plating	Nickel
Strain relief	POM

Environmental	
Temperature range	-20 °C to +70 °C
Solderability complies with	IEC68-2-20



Patch Panels

Stage Box



NYS-SSR-8



NSB2A-20/4



NSB2B-12/4



NSB1C-8/0

THE SMART WAY TO CONNECT

- Simple connection method for audio system
- 8 I/O 1/4" patch panels
- Rugged metal housing
- Convenient assembly, easy to use

- Special module system for size and space customization
- Personalized I/O connector combination, optional various length
- Convenient assembly
- 3 pole IDC XLR, no stripping or soldering required
- Does not contain self-adhesive channel digital label, need to be ordered separately
- Cost-effective

NYS SSR-8

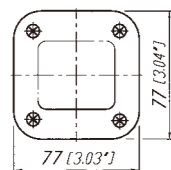
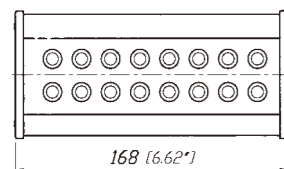

A型

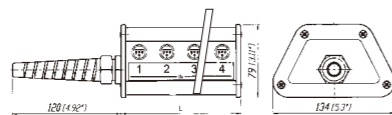

A	Length
NSB1A	132 (5.2')
NSB2A	252 (9.93')
NSB3A	372 (14.65')
NSB4A	491 (19.33')

B

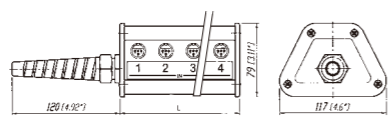

B	Length
NSB1B	132 (5.2')
NSB2B	252 (9.93')
NSB3B	372 (14.65')

C

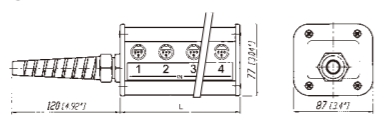

C	Length
NSB1C	132 (5.2')
NSB2C	252 (9.93')
NSB3C	372 (14.65')

Ordering Information

Article Name	Details
--------------	---------

Patch Panels

NYS-SSR-8	8 line in - 8 line out 1/4" patch panels
-----------	--

Stage Box - A

NSB1A-8/4	Length 1, 8 line in (female/output) - 4 line out (male/ input)
NSB2A-12/4	Length 2, 12 line in (female/output) - 4 line out (male/ input)
NSB2A-20/4	Length 2, 20 line in (female/output) - 4 line out (male/ input)
NSB3A-32/4	Length 3, 32 line in (female/output) - 4 line out (male/ input)
NSB4A-40/4	Length 4, 40 line in (female/output) - 4 line out (male/ input)
NSB4A-40/8	Length 4, 40 line in (female/output) - 8 line out (male/ input)

Stage Box - B

NSB1B-8/0	Length 1, 8 line in (female/output)
NSB2B-12/4	Length 2, 12 line in (female/output) - 4 line out (male/ input)
NSB2B-16/0	Length 2, 16 line in (female/output)
NSB3B-20/4	Length 3, 20 line in (female/output) - 4 line out (male/ input)

Stage Box - C

NSB1C-8/0	Length 1, 8 line in (female/output)
NSB2C-12/4	Length 2, 12 line in (female/output) - 4 line out (male/ input)
NSB3C-20/4	Length 3, 20 line in (female/output) - 4 line out (male/ input)

(Delivery of bulk products, including boxes, cover plates, brackets, cable joints and screws)

Specification Patch Panels Stage Box

Electrical

Rated current	depends on mating connector	2 A
Contact resistance	depends on mating connector	< 5 mΩ
Insulation resistance	>1 GΩ	>1 GΩ
Dielectric strength	500 V dc	500 V dc

Mechanical

Lifetime	> 1'000 mating cycles	> 1'000 mating cycles
Insertion / Withdrawal force	≤ 10 N / ≥ 10 N	≤ 10 N / ≥ 10 N
Cable O.D.	-	15 -20 mm
Wiresize	-	0.22 mm ² / 24 AWG or 0.14 mm ² / 26 AWG

Material

Housing	Al	Al
Square plate	-	POM
Cover	Thermoplastic	Thermoplastic
Contact	Brass / Bronze	Nickel plated
Temperature range	-25 °C to +70 °C	-25 °C to +70 °C